

Thruster Brakes Eldro (SMD 300-23)

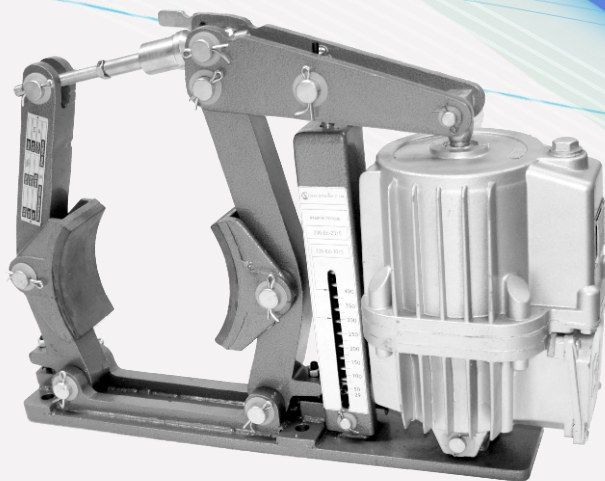

Brake Features

- SMD Thruster brakes are steel fabricated frames with Eldro Thruster.
- Robust and rugged design to withstand arduous environment in steel, Rolling Mills, Elevators, Lifts Cements and other heavy engineering plants.
- Excellent designs & good manufacturing process ensure a reliable product.
- Consistent braking torque due to selected and tested brake lining material.(asbestos free)
- The design ensures efficient distribution of forces.
- Ease Of maintenance and replacement of brake shoe without dismounting the brake.
- Compact designs and elegant aesthetic looks.



Technical Data

Item	Brake	Thruster
Model	SMD 300-23	Eldro 23-5
Lifting Force	-	230N/23 Kg
Drum Dia.	300 mm	-
Breaking Torque	42 Kg-m	-
Stroke	-	50 mm
Oil Capacity	-	1.6 Liters
Rated Voltage	-	415 VAC, 3ø Ph
Ingress Protection	-	IP 65 (IS/IEC -60529(2001)
Operating Temperature	-	+50° C
Power at	-	165 Watt
Weight	50 Kg	10 Kg
Current At 415 VAC	-	0.5 Amps

Thruster Specifications

The centrifugal pump and motor are immune from external overloading. Standard motor design is suitable for 415 Volts / 50 Hz / 3-Phase supply. Other voltage and frequencies can be offered against request. The star connected, Class F windings have internal star point, and the three supply phases can be connected on the terminal board, irrespective of the phase sequence. The bi-directional radial flow impeller works with equal performance efficiency in both directions.

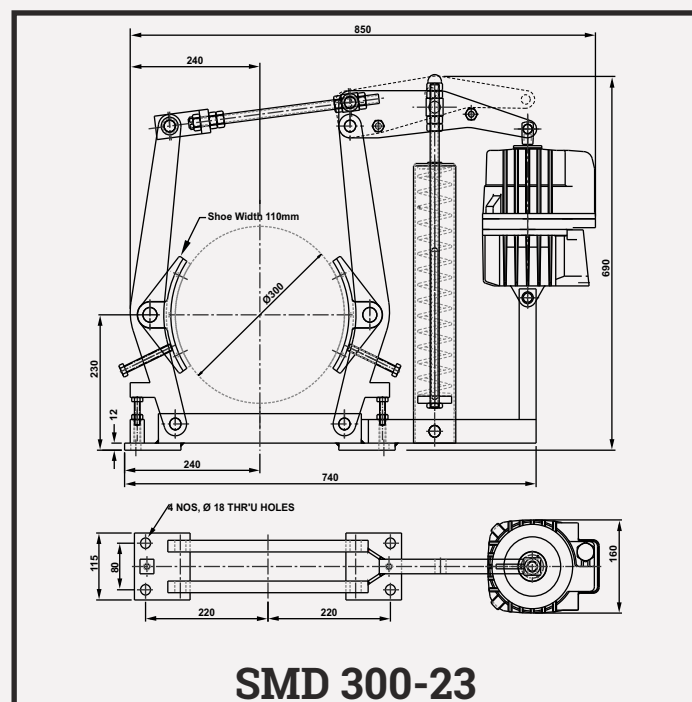
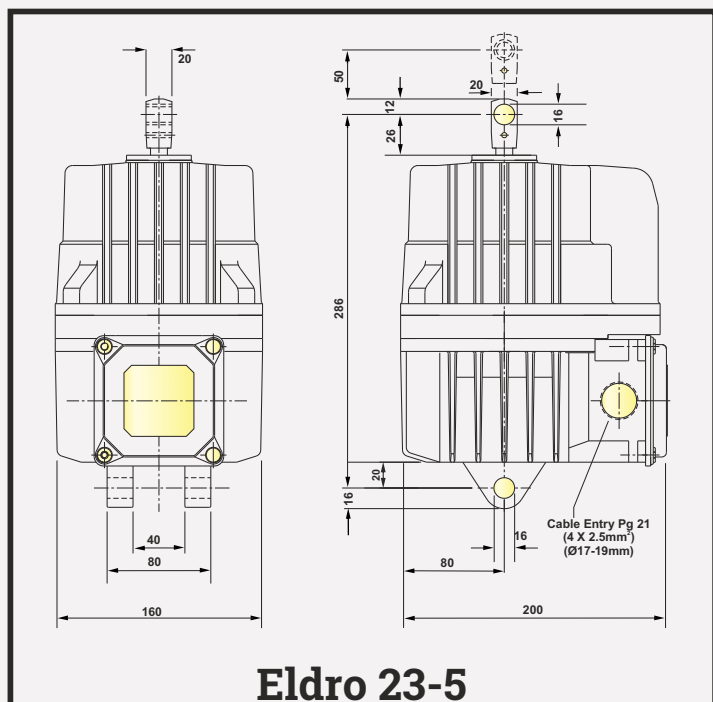

Speed-O-Controls Pvt. Ltd.

H. O. Unit - I : C-15/16, Nand Jyot Industrial Estate, Andheri-Kurla Road, Mumbai - 400072,
Tel : (022) 42469700-30
Fax : (022) 42469797
E-mail : sales@socgroup.in

Unit - II : Plot No. 4912, G. I. D. C., Phase IV, Vatva, Ahmedabad - 382445
Tel.: (079) 40083201/2/3/4,
Fax : (079) 25841056,
E-mail : sales.amd@socgroup.in

Visit us at :
www.speedocontrols.com
www.socremote.com

July, 2017